

## VIBE Wall Installation - Velcro

### Acoustical Wall Tile

These installation suggestion consists of a common process for tile installation. Installers should rely upon their own professional experience and understanding of their unique requirements to ensure a successful install.

---

### Optional Tools Needed for Velcro Installation

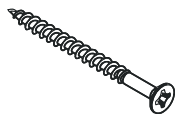

Screw

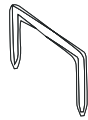

Staple

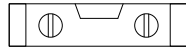

Level

---

### Items Included

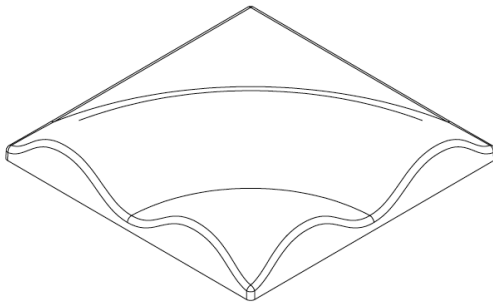

Vibe Molded Tiles

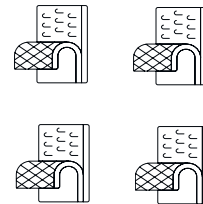

(4) Velcro Squares  
attached to each tile

- 
1. Unwrap Vibe Tiles from plastic wrap.

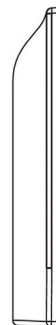
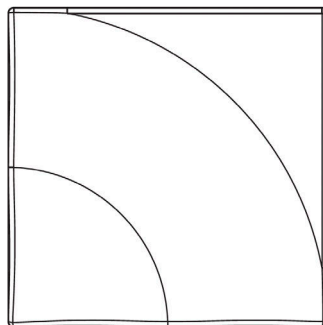

2. Mark desired installation area(s) on the wall and orient tiles to achieve your desired look.

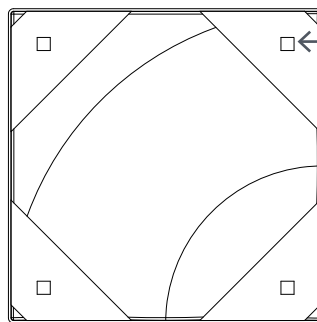
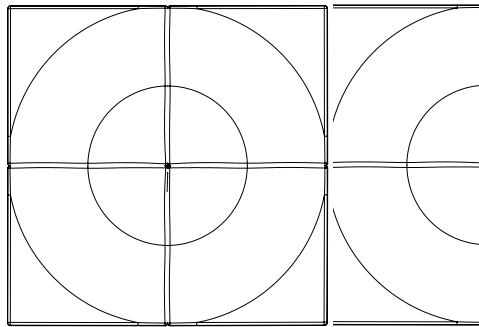

Velcro Square

Velcro squares are already located on the four corners on the back of each Vibe Tile.

3. Peel the adhesive backing from the velcro and align the Vibe Tile as needed on the wall. Push on the Vibe Tile to ensure the velcro adhesive sticks to the wall. Use a level, if desired, to achieve an even look.

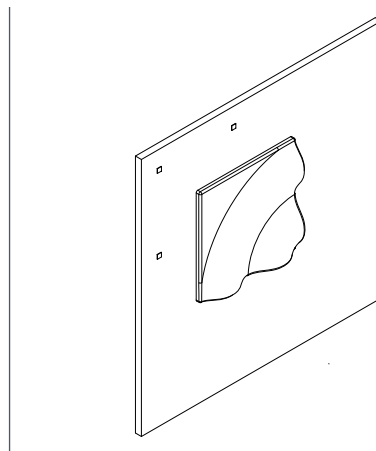
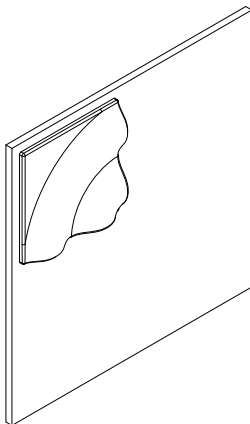

NOTE: Allow adhesive on velcro backing to fully cure before attempting to separate Vibe from the velcro. Failing to do so may cause the wall to become damaged.

For a more secure hold, staple or nail the velcro backing to the wall. Once secured, press the Vibe Tile to the wall to reconnect the Velcro's hoop and loop sides.



- Repeat step 3 to continue to attach the Vibe Tiles to the wall. Orient them in a way to achieve desired pattern.

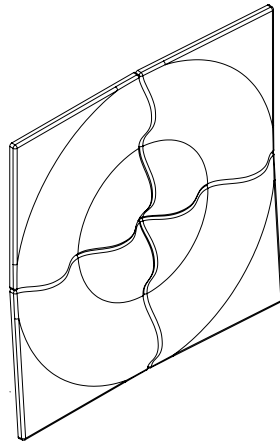

Pattern Example

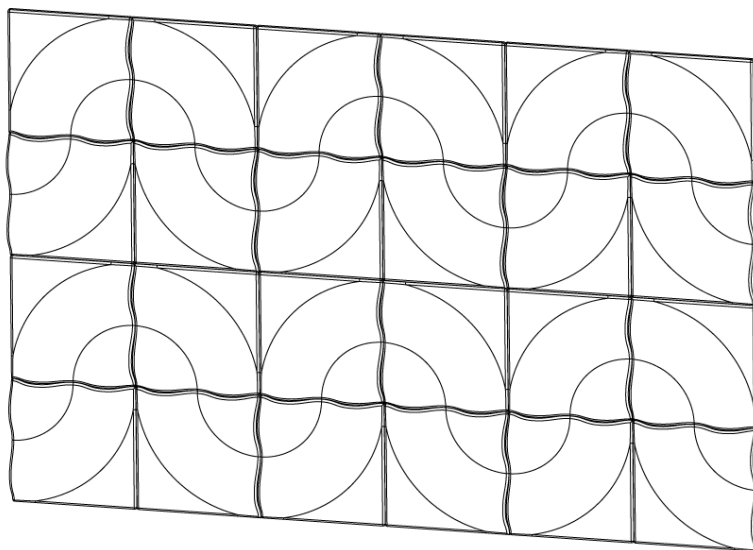

Pattern Example

## VIBE MOLDED Wall Installation - Sway, Nami, Clif

These installation suggestions consist of a common process for VIBE MOLDED installation. Installers should rely upon their own professional experience and understanding of their unique requirements to ensure a successful install.

VIBE will look best when installed with no gaps between ends or rows.

---

### Tools Needed for Impaler Installation

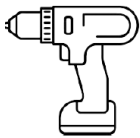

Drill



Sheet Rock  
Screw

### Tools Needed for Non-Impaler Installation

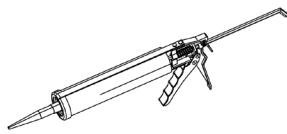

Liquid Nail

or



3095 Carpet Glue  
Adhesive

### Items Included

---

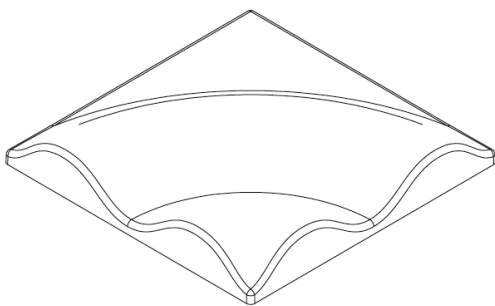

Vibe Molded Panels

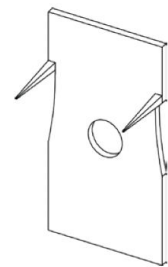

Impaler Clips

1. **IMPALER WALL INSTALL:** Direct install to sheetrock with screws. Use your drill to attach impaler clips to the desired location on your interior sheetrock wall.

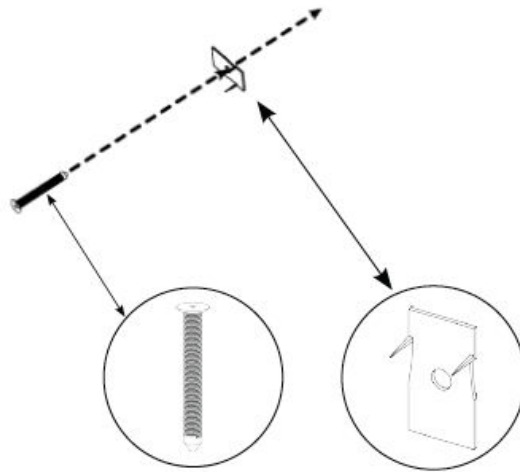

2. Repeat the process three more times so a total of four (4) impaler clips are placed on the wall behind each VIBE panel.

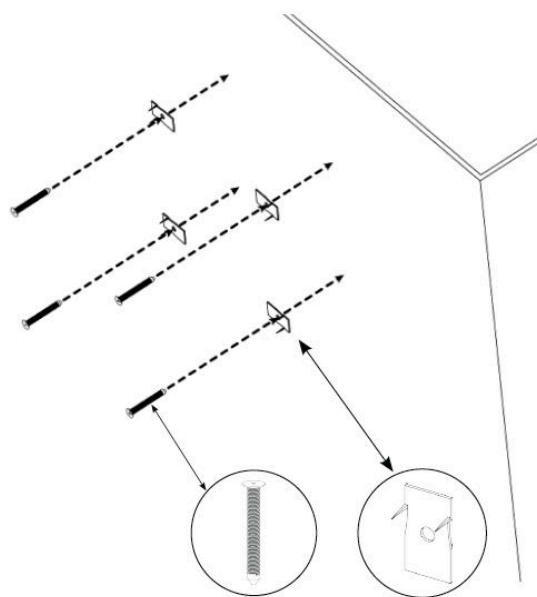

3. Now that your impaler clips are secure on the wall, use pressure to attach the VIBE panel to the impaler clips.

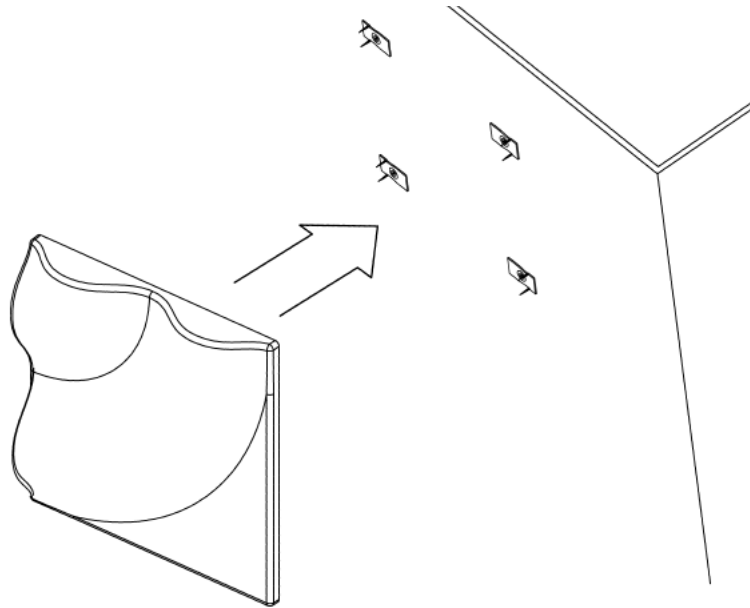

4. Repeat the process until your desired pattern is achieved.

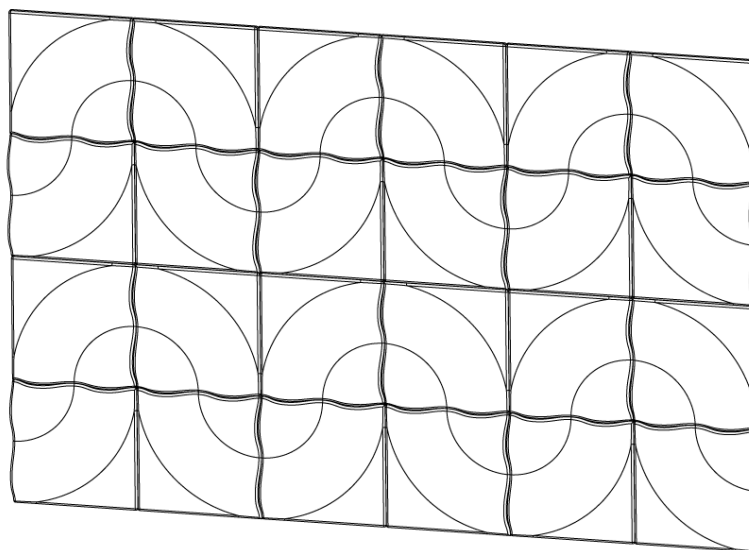

1. NON-IMPALER WALL INSTALL: Apply a generous amount of Liquid Nail, 3095 Carpet Glue Adhesive or other comparable adhesive product to the back of a VIBE MOLDED panel. Use pressure to apply the panel to your interior sheetrock wall.

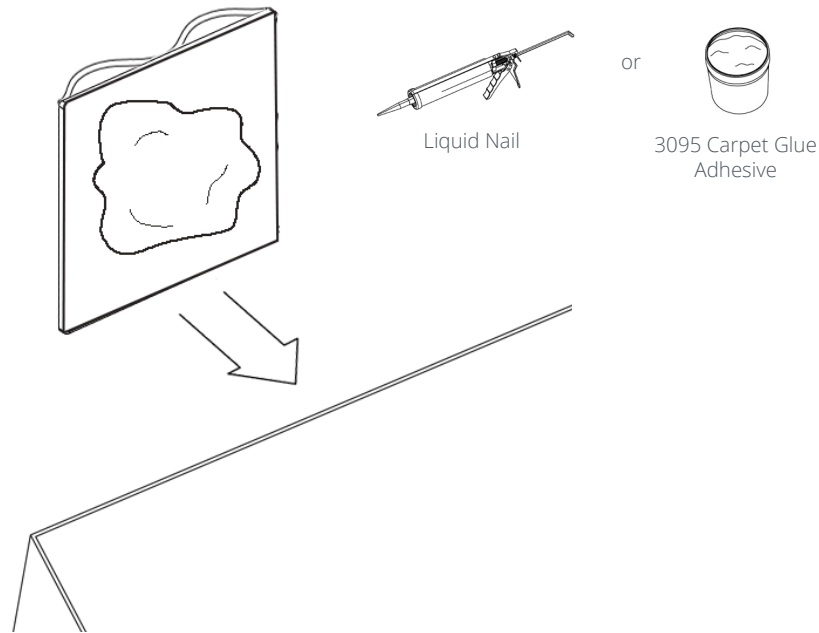

2. Repeat the process until your desired pattern is achieved.

