

## PILO Installation

### Acoustical Wall Tiles

These installation suggestions consist of a common process for PILO installation. Installers should rely upon their own professional experience and understanding of their unique requirements to ensure a successful install.

*\*Variations and inconsistencies in the wall may affect the installation outcome. If uneven walls are a concern, please reach out to us for a spacer recommendation. Product may have up to 1/16" variance.*

### Tools Needed



Drill

### Items Included

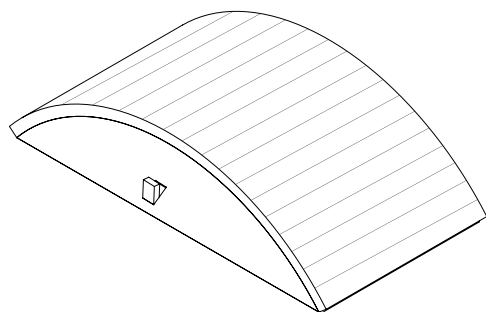

PILO full Tiles

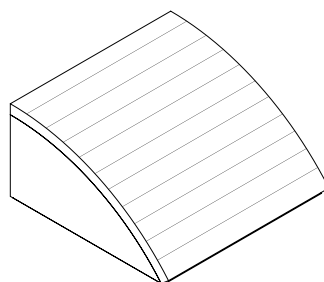

PILO half Tiles



Screws

1. Unwrap tiles from plastic wrap. Confirm tile dimensions match your needs.

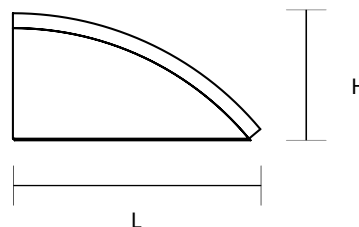
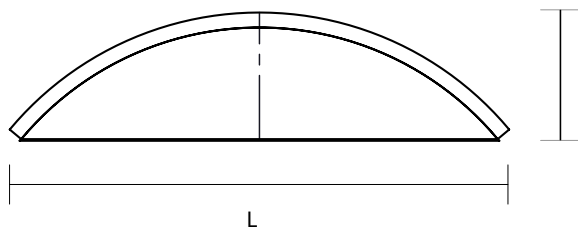

## PILO Installation

Acoustical Wall Tiles

---

2. Locate the STD strip (Secret Trap Door) at all corners and carefully pull it to open the trap door.

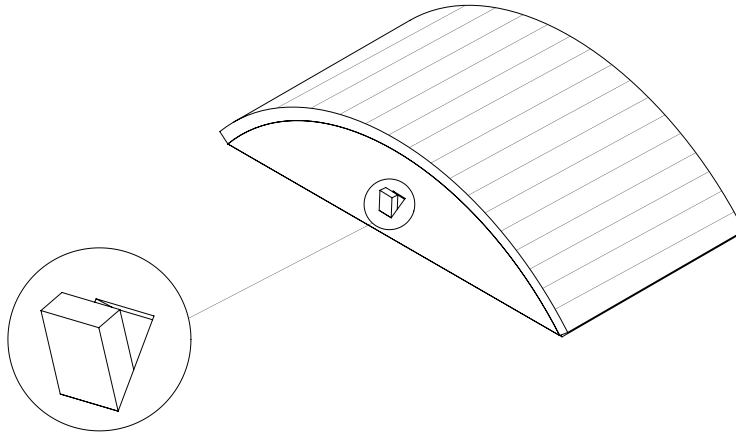

3. Pull the STD (Secret Trap Door) strip to open the trap door - use caution to not tear the hinge off.

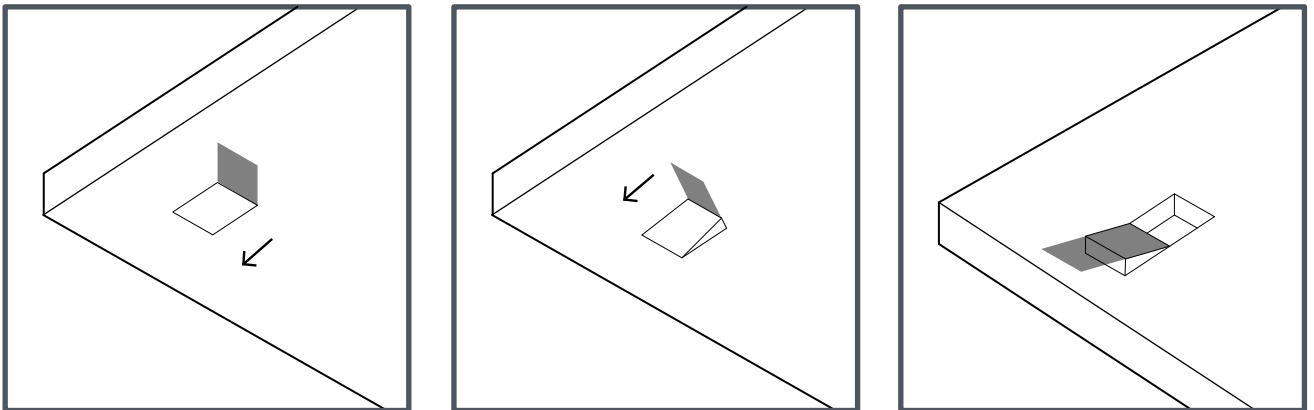

## PILO Installation

Acoustical Wall Tiles

---

4. Pull all the trap doors open before installing.

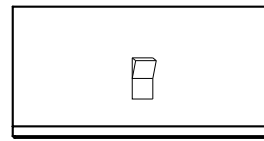
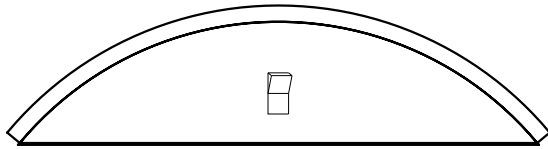

5. Use the drywall screw to mount.

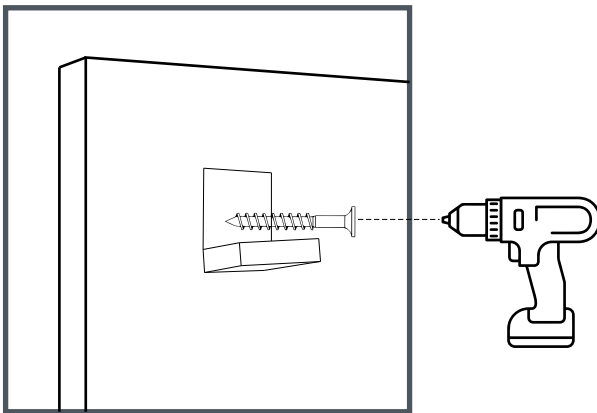

6. Close the door to finish installation.

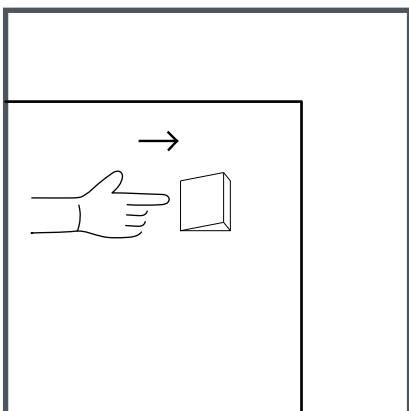

## PILO Installation

Acoustical Wall Tiles

---

### 7. Example layouts:

