

SQH@MFKD Installation

Acoustical Wall Tiles

Sgdrd hms`kk`shmr t f f drshmr bnm h's ne`bnl | nmoqnbdr r enq SQH@MFKD hms`kk`shmr hms`kk`dqr r g nt kc qplk t onmsg dhq nv moqnedr r hnm`kdwodqdrdbd `nc t mc dqr s`nc hmf nesg dhqt nrtpt d qdpt hqll dmsr sn dmr t qd `rt bbdrr et k hms`kk`

Tools Needed



Drill



Putty Knife



Construction Adhesive



Liquid Nail



Box Cutter

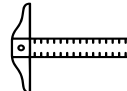

Straight Edge

Items Included

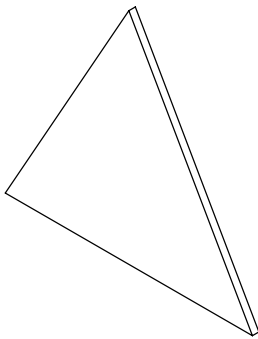

TRIANGLE Tiles

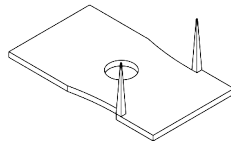

Impeller Clips



Screws

1. Unwrap tiles from plastic wrap. Confirm tile dimensions match your needs.

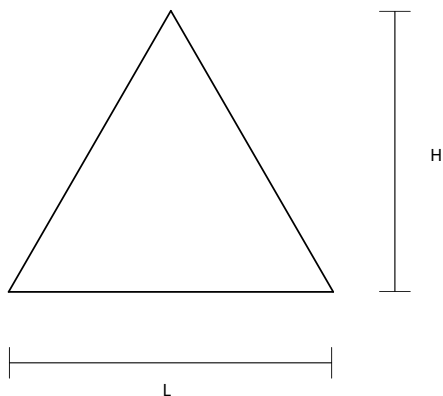

TRIANGLE Installation

Acoustical Wall Tiles

2. Measure the length and height of the wall. Find center of the wall.

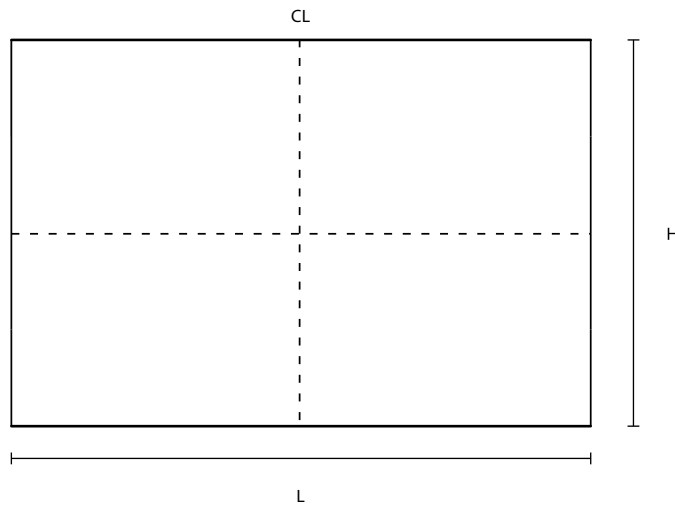

3. **For the non-impeller clip option:** Lay the tile on the ground and use the putty knife to place the carpet glue to one TRIANGLE tile at a time, or use Liquid Nail. The adhesive has 20-25 minutes of drying time.

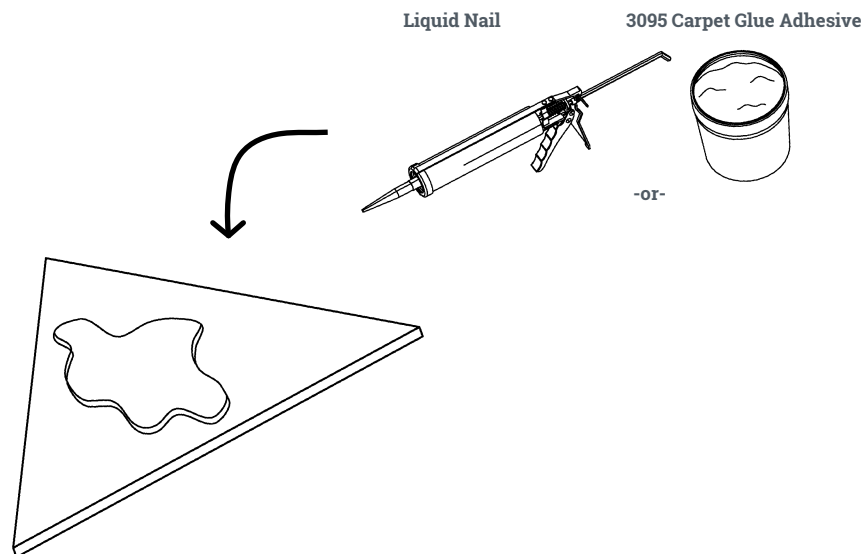

TRIANGLE Installation

Acoustical Wall Tiles

4. Position the tile on the wall.

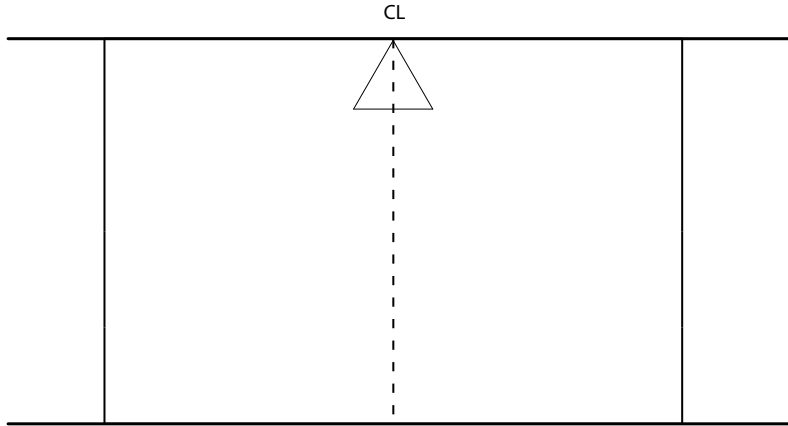

5. Use a box cutter and metal ruler to cut off the excess material to fit on the wall.

Tip for clean edges: Use smooth continuous motion to cut through half the thickness of the material; using the edge of the ruler as your guide. Go over the same line again to complete the cut.

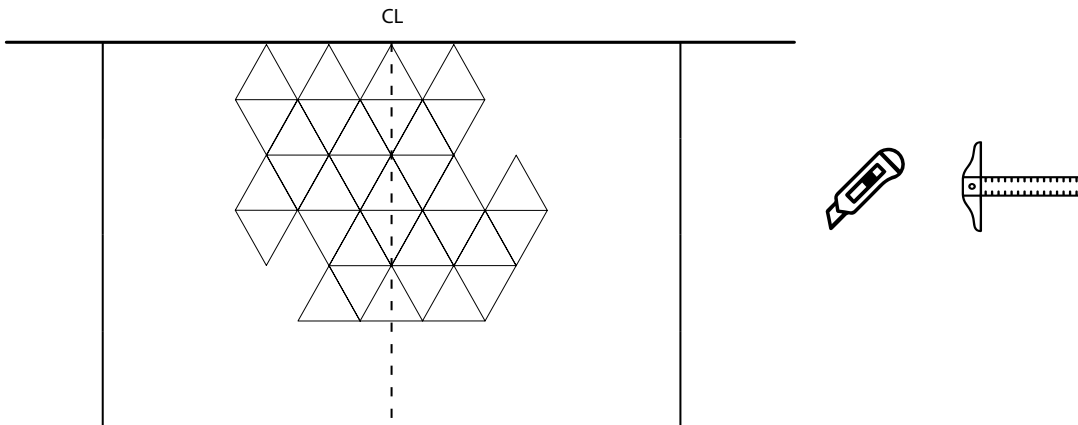

6. Layout desired pattern on wall to complete the installation. **For impeller clip method,** see next page.

TRIANGLE Installation

Acoustical Wall Tiles

7. **For impeller clip method:** Position the tile on the wall and mark 3 points on the wall where the impeller clips will be placed behind the tile.

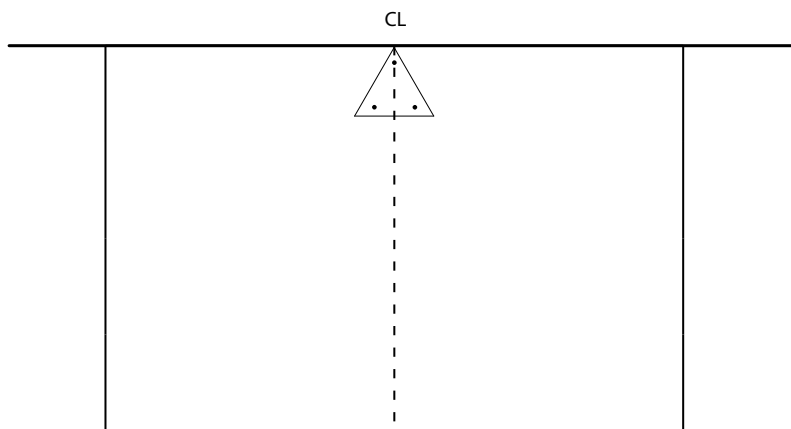

8. Take the screws and impeller clips and drill the clips on the marked points on the wall. Use caution, the impeller clips are sharp.

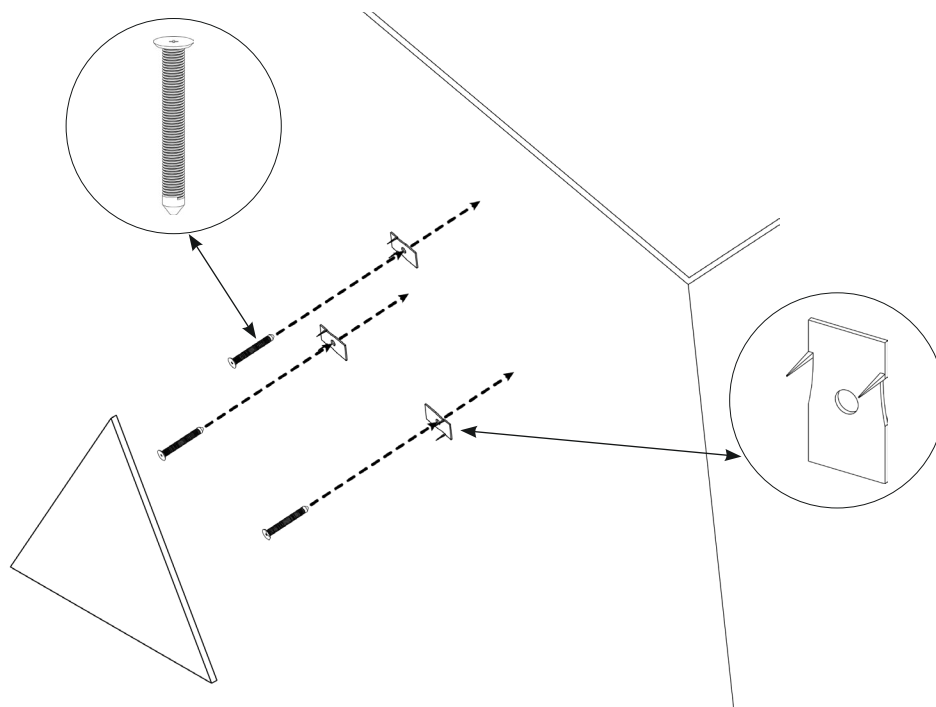

TRIANGLE Installation

Acoustical Wall Tiles

9. Take the TRIANGLE tile and place on the impeller clips and press firmly. Repeat the process to cover the wall.

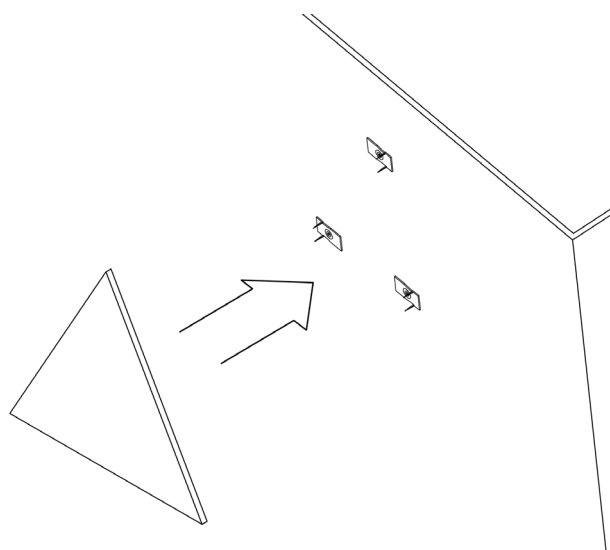

10. Cover the wall in desired pattern to complete the installation. Example layout:

